

Low Voltage Battery

USER MANUAL

LB-5S-G2
LB-10S-G2
LB-15S-G2
LB-20S-G2

Legal Notice

Hoymiles has made every effort to ensure the accuracy and completeness of this manual. However, this manual may be changed and revised due to product enhancements or user feedback.

Hoymiles reserves the right to modify this manual without prior notice at any given time. The latest version of this manual can be found by visiting the Hoymiles official website www.hoymiles.com or scanning the QR Code below.



Warranty

Follow the installation instructions in this manual to ensure warranty compliance and reliability. The current warranty conditions can be accessed at www.hoymiles.com.

Contact Information

If you have technical queries or any questions concerning our products, please contact our support through the Hoymiles service portal:

**Germany**

service.de@hoymiles.com

Italy

service.it@hoymiles.com

Poland

service.pl@hoymiles.com

Rest of the EU

service.eu@hoymiles.com

Spain

service.es@hoymiles.com

Netherlands

service.nl@hoymiles.com

Finland

service.fi@hoymiles.com

Australia & New Zealand

service.au@hoymiles.com

France

service.fr@hoymiles.com

Norway

service.no@hoymiles.com

Austria

service.at@hoymiles.com

Asia & Pacific

service.asia@hoymiles.com

**Germany**

+49 6994322186

France

+33 159131589

Netherlands

+31 852736388

Poland

+48 918821656



hoymiles.com

Contents

1	About This Manual	1
1.1	Purpose	1
1.2	Audience	1
1.3	Validity	1
2	Safety Information	2
2.1	Safety Symbols	2
2.2	Additional Symbols	2
2.3	Intended Use	3
2.4	Safety Instructions	4
3	Transportation and Storage	5
3.1	Transportation Requirements	5
3.2	Storage Requirements	5
4	Product Introduction	6
4.1	Product Overview	6
4.2	LED Indicators	7
4.3	Button Instruction	8
4.4	System Diagram	9
4.4.1	Single Battery System	9
4.4.2	Multi-battery System	10
5	Installation Instruction	12
5.1	Unpacking	12
5.2	Environmental Requirements	13
5.3	Space Requirements	14
5.4	Stackable Quantity	14
5.5	Installation Tools	15
5.6	Installation Steps	15
6	Electrical Connection	19
6.1	Single-battery System	19
6.1.1	Power Cable Connection	19
6.1.2	Communication Cable Connection	19
6.2	Multi-battery System	20
6.2.1	Power Cable Connection	20
6.2.2	Communication Cable Connection	20
7	System Commissioning	21
7.1	Preparation	21
7.2	System Power-on	21
8	System Maintenance	22
8.1	System Power-off	22
8.2	Routine Maintenance	22
8.3	Troubleshooting	23

9 Decommissioning 24
9.1 Removing the Product24
9.2 Packing the Product24
9.3 Disposing of the Product24

10 Handling Precautions and Guidelines for Product.....25

11 Technical Datasheet.....27

1 About This Manual

1.1 Purpose

This manual provides information on the installation, electrical connections, operation, and maintenance of the LB-(5-20)S-G2 series battery.

Please consider the following before installation:

- Carefully read this manual before operation.
- Keep this manual for reference.

1.2 Audience

This manual is intended for use by qualified persons only. Qualified persons must have the following skills:

- Knowledge of how a battery works.
- Knowledge of how an inverter works.
- Training in how to deal with the dangers and risks associated with the installation, maintenance, and use of electrical devices.
- Training in the installation, commissioning, and maintenance of electrical devices.
- Knowledge of and compliance with all applicable laws, standards, and directives.

1.3 Validity

This manual is valid for:

- LB-5S-G2
- LB-10S-G2
- LB-15S-G2
- LB-20S-G2

NOTE

Model identifier:

LB - 5S - G2
T TT T
A BC D

[A]: Series Name (Low Voltage Battery)

[B]: Total Energy (5.12 kWh)

[C]: Battery Type (Stackable Battery)





[D]: Generation (The Second Generation)

2 Safety Information

The LB-(5-20)S-G2 series battery is designed and tested according to international safety requirements. However, certain safety precautions must be taken while installing, operating, and maintaining the battery. Please carefully read all safety instructions before installation, and observe all these safety instructions.







2.1 Safety Symbols











Safety symbols are used in this manual as follows:

Symbol	Description
 DANGER	This symbol indicates potential risks that, if not avoided, may lead to death or serious physical injury.
 WARNING	This symbol indicates potential risks that, if not avoided, may lead to personal injury or device damage.
 CAUTION	This symbol indicates potential risks that, if not avoided, may lead to device malfunctions or financial losses.
 NOTICE	This symbol indicates potential risks that, if not avoided, may lead to minor injury or damage to the equipment.
 NOTE	This symbol indicates an important step or tip that leads to the best results but is not safety or damage-related.

2.2 Additional Symbols

The product label contains the following symbols with their meanings described below:

Symbol	Usage
	Electric hazard This symbol indicates that there is a danger of electric shock. Failure to pay attention to the procedures, practices, or improper implementation may cause injuries or death.
	Warning This symbol indicates that there is a hazard that could damage the product.
	The product should be stored and installed away from explosive materials.
	Playing around the product is not allowed.
	The product must be stored and installed far from flammable materials.
	Please wear protective goggles when installing, operating, and maintaining the product.
	WEEE Designation. Do not dispose of the product together with household waste. Dispose of the product in accordance with local disposal regulations for electronic waste.

	<p>CE mark. The product complies with the requirements of the applicable EU directives.</p>
	<p>The battery is recyclable. The battery can be recycled by a professional recycling organization. Please refer to the relevant local regulations.</p>
	<p>Observe the documentation. Read and understand all documentation supplied with the product.</p>
	<p>This side up! This package must always be transported, handled, and stored in such a way that the arrows always point upwards.</p>
	<p>Fragile. The package/product should be handled carefully and should never be tipped over or slung.</p>
	<p>Keep dry! The package/product must be protected from excessive humidity and must be stored under cover.</p>
	<p>No more than six (6) identical packages (Control Box) are to be stacked on each other.</p>
	<p>No more than four (4) identical packages (Battery Pack) are to be stacked on each other.</p>
	<p>No more than seven (7) identical packages (Base) are to be stacked on each other.</p>
	<p>No Stepping.</p>

2.3 Intended Use

The LB-(5-20)S-G2 series is a BESS which is for residential applications.

- It is a low voltage Li-ion BESS.
- It can be installed indoors and outdoors. For details, please refer to [“5.2 Environmental Requirements”](#).
- It must only be used as stationary equipment.
- Alterations to the product are not allowed unless authorized in writing by the supplier.
- Unauthorized alterations will void the guarantee and warranty claims. Hoymiles will not be liable for any damage caused by such unauthorized alterations.
- It is not suitable for supplying power to life-sustaining medical devices.
- Please ensure that there will be no personal injury due to the power outage of the battery system.
- It can only be used in countries where it is approved by battery suppliers.
- It should be used in accordance with the information provided in this document and local applicable standards and directives. Any other application may cause personal injury or property damage.

- The label must be permanently attached to the product.
- The safety instructions in this document are only supplements to local laws and regulations. Please follow local laws and regulations during installation, operation, and maintenance.

2.4 Safety Instructions

To prevent personal injury and property damage and to ensure the long-term operation of the product, read this section carefully and observe all safety information at all times. Failure to observe the prescribed instructions may potentially void the manufacturer's warranty. If in doubt, please contact Hoymiles.

DANGER

Danger to life due to electric shock where surge protection is not used!

If there is no surge protection, a voltage surge can be conducted into the building and to other connected devices in the same system through power cables, network cables, or other types of cable. Touching live parts and cables may result in death or lethal injury due to electric shock.

- Ensure all devices in the same system and the inverter are integrated with an existing surge protection system or device.
- Install the surge protection device in accordance with local laws and regulations.

WARNING

Danger to life due to overvoltage!

Overvoltage can damage a measurement device and result in voltage being present in the enclosure of the measurement device. Touching the live enclosure of the measuring device results in death or lethal injuries due to electric shock.

- Only use measurement devices with a higher voltage range than the system battery voltage.
- Do not touch hot surfaces before it cools down.

Risk of injury due to the weight of the product!

- If the product is lifted incorrectly or dropped while being transported or mounted, it may result in injury.
- Lift and transport the product carefully.
- Wear suitable personal protective equipment, and comply with local regulations during installation, operation, and maintenance.

Fire hazard!

- If the fire is not from the battery or not spread to the battery, please use FM-200 or a carbon dioxide fire extinguisher to put out the fire.
- If the battery pack catches fire, do not attempt to put out the fire and evacuate immediately. Keep damaged batteries isolated and call the local fire department. Immediately seek medical in case of breathing in toxic fumes.

Keep away from water!

- Keep the battery packs away from water. If any part of the battery system is submerged, there is a risk of electric shock and internal short-circuit.
- Do not reuse the battery if it has been submerged in water.

NOTICE

Damage to the battery system due to electrostatic discharge!

Internal components of the battery system can be irreparably damaged by electrostatic discharge.

- Ground yourself before touching any component.

3 Transportation and Storage

3.1 Transportation Requirements

- The battery has been certified to UN 38.3 and passed related tests. As it is classified as class 9 dangerous goods, it must be transported in accordance with specific regulations.
- Batteries must be transported separately.
- Ensure that the packages, labels, and other markings are correct and intact before and during the transportation.
- During transportation, keep the battery in its correct direction in case of falling down.
- The battery should be carefully transported to avoid short circuits, damage, fire, or explosion, and to ensure personal safety.
- Pay attention to the weight of the product to avoid injury when handling the product.
- Do not hold the terminals or cables to move a battery.
- Wear personal protective equipment when handling the batteries.
- Personnel working with batteries must be well trained in proper lifting and handling procedures.

3.2 Storage Requirements

Suitable storage is required if the battery is not installed immediately.



- Store the battery in the original package, and do not unpack the battery.
- It is recommended to store the product in an environment with a temperature between 15°C and 35°C and a relative humidity between 10% and 95%, without condensing.
- The package with the battery shall not be tilted or inverted.
- Do not place any objects on the top of the battery pack.
- The battery should be stored in a cool and clean place where it can be protected from direct sunlight and bad weather such as rain, snow, or lightning.
- Keep the package away from flammable, explosive, and corrosive materials.
- If the battery has been stored for three months or longer, it must be fully inspected and tested by authorized personnel before it can be put into operation.
- The battery SOC should be 45%-50%. The battery needs to be recharged every 6 months if it is not used, and it is recommended to store it after it is first charged to 100%, then discharged to 50%, and finally powered off.
- The battery needs to be maintained at a maximum interval of 6 months.
- The requirements for the recharge interval after the battery is fully discharged are as follows.
 - a) If the environmental temperature is 45°C-50°C, it should be recharged within 7 days;
 - b) If the environmental temperature is 35°C-45°C, it should be recharged within 15 days;
 - c) If the environmental temperature is no more than 35°C, it should be recharged within 30 days.
- When the device is unused, the battery SOC should be 45%-55%, and the battery output should be disconnected to prevent the battery from draining.
- During the storage period of the system, professionals should regularly check the system to check whether the cables are loose, and clean the surface of the system; if any defects are found, please contact the dealer in time.

4 Product Introduction

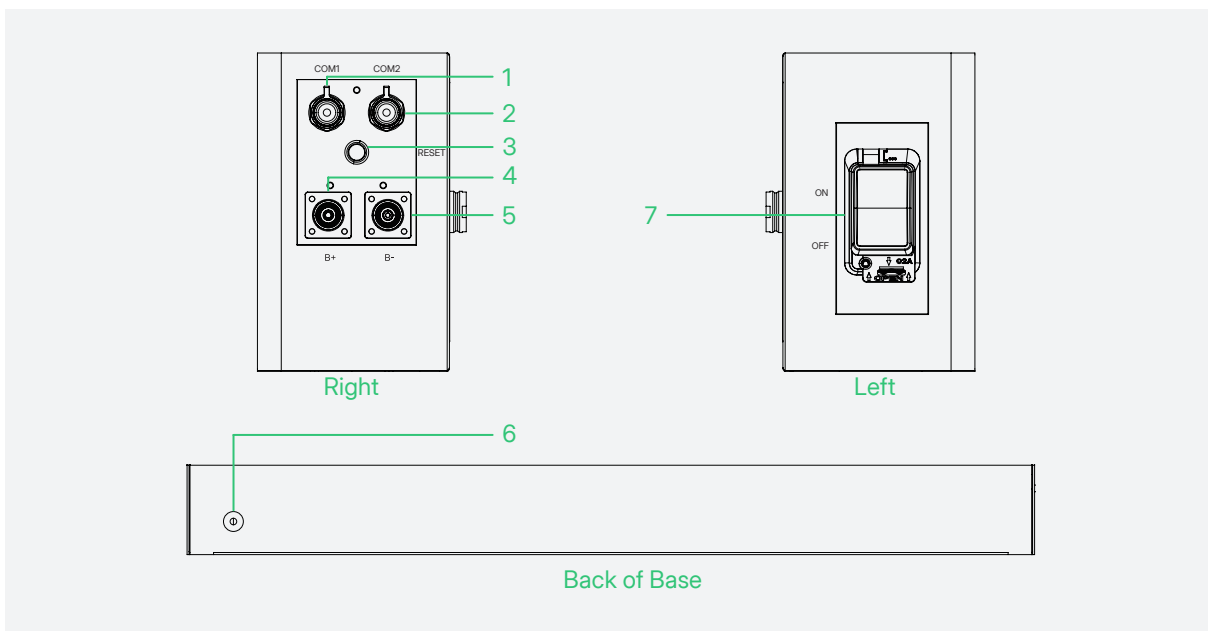
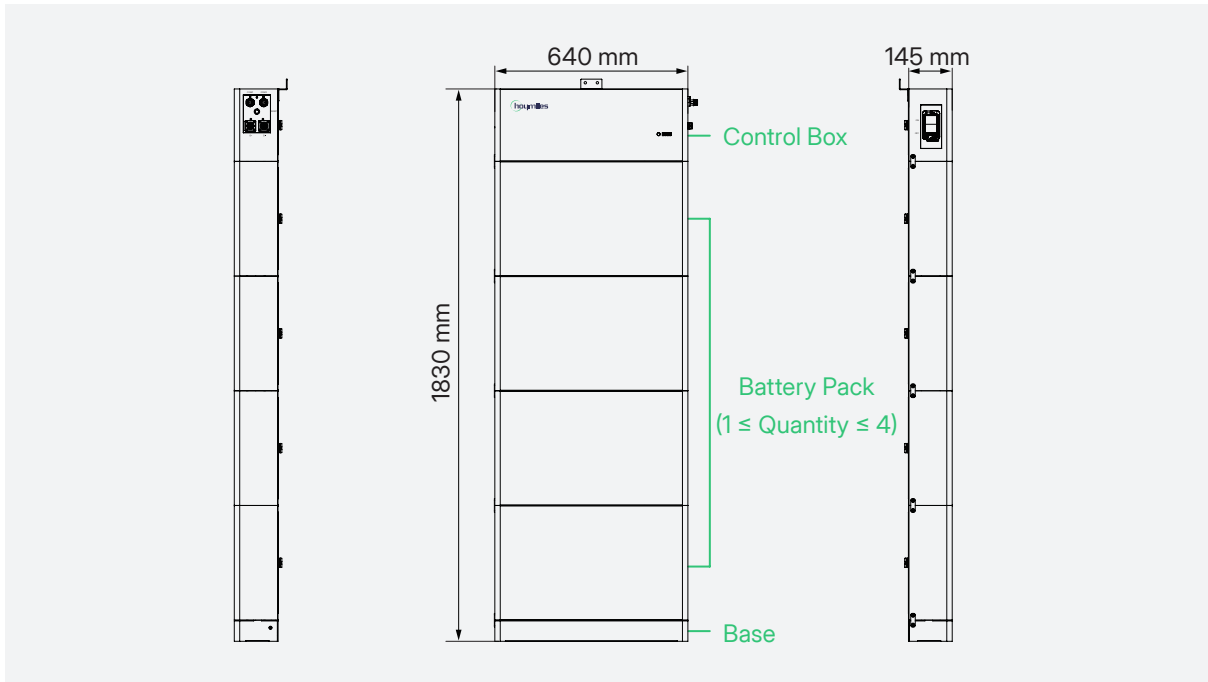
4.1 Product Overview









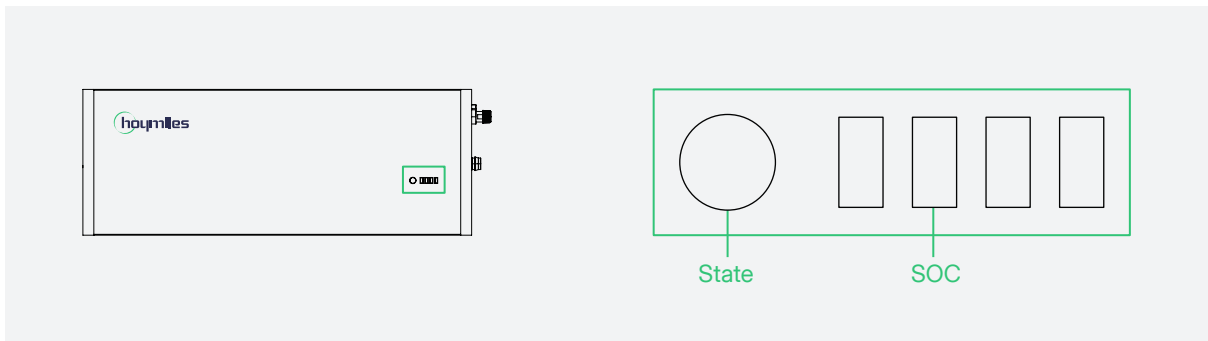

No.	Description
1	COM1
2	COM2
3	RESET
4	Positive Terminal
5	Negative Terminal
6	Ground Terminal
7	Circuit Breaker

Terminal	PIN	Definition							
		1	2	3	4	5	6	7	8
COM1		NC	NC	NC	CAN1H	CAN1L	NC	NC	NC
COM2		4852A-DEBUG	4852B-DEBUG	4851A-INT	CAN1H	CAN1L	4851B-INT	MASTER-OUT	MASTER-IN

4.2 LED Indicators

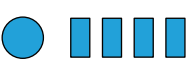
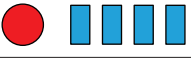

Indicator	Indicator Status	Battery Status
	Solid blue.	The battery works normally or is in standby.
	Solid red.	A fault occurs.
	1/4 LED on.	SOC is 0-25%.
	2/4 LEDs on.	SOC is 25%-50%.
	3/4 LEDs on.	SOC is 50%-75%.
	All LEDs on.	SOC is 75%-100%
	Flashing blue (0.5s gap).	The battery is in precharge; The battery is in self-check; The battery is being upgraded.
	Flashing (0.5s gap).	Communication failure.
	The indicators are off.	The battery is turned off.

4.3 Button Instruction

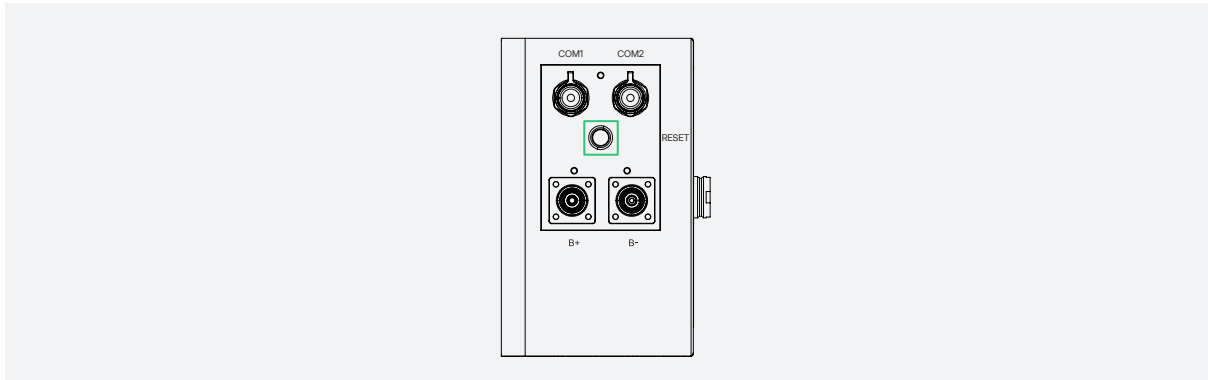

Activation

When the BMS is in sleep mode, press the button for 3s to activate the BMS. At this moment, the BMS will be in self-check state, and all indicators flash blue (0.5s gap). After it completes self-check, it will enter the running mode, and the "State" indicator will be solid blue.

Sleep

When the BMS is in running mode, press the button for 3s, the "State" indicator will be solid green, and the "SOC" indicators will be in current status. All indicators will be off after you release the button.

Reset

When the BMS is in running mode, press the button for 10s, the indicators will be off and the BMS will be reset. Press the button for 3s to activate it again, and at this moment, all indicators flash blue (0.5s gap).

4.4 System Diagram

NOTICE

- It is recommended that a circuit breaker between the inverter and the battery be installed in accordance with local laws and regulations.
- Power cables for parallel connection will not be provided by Hoymiles and should be purchased separately.

4.4.1 Single Battery System

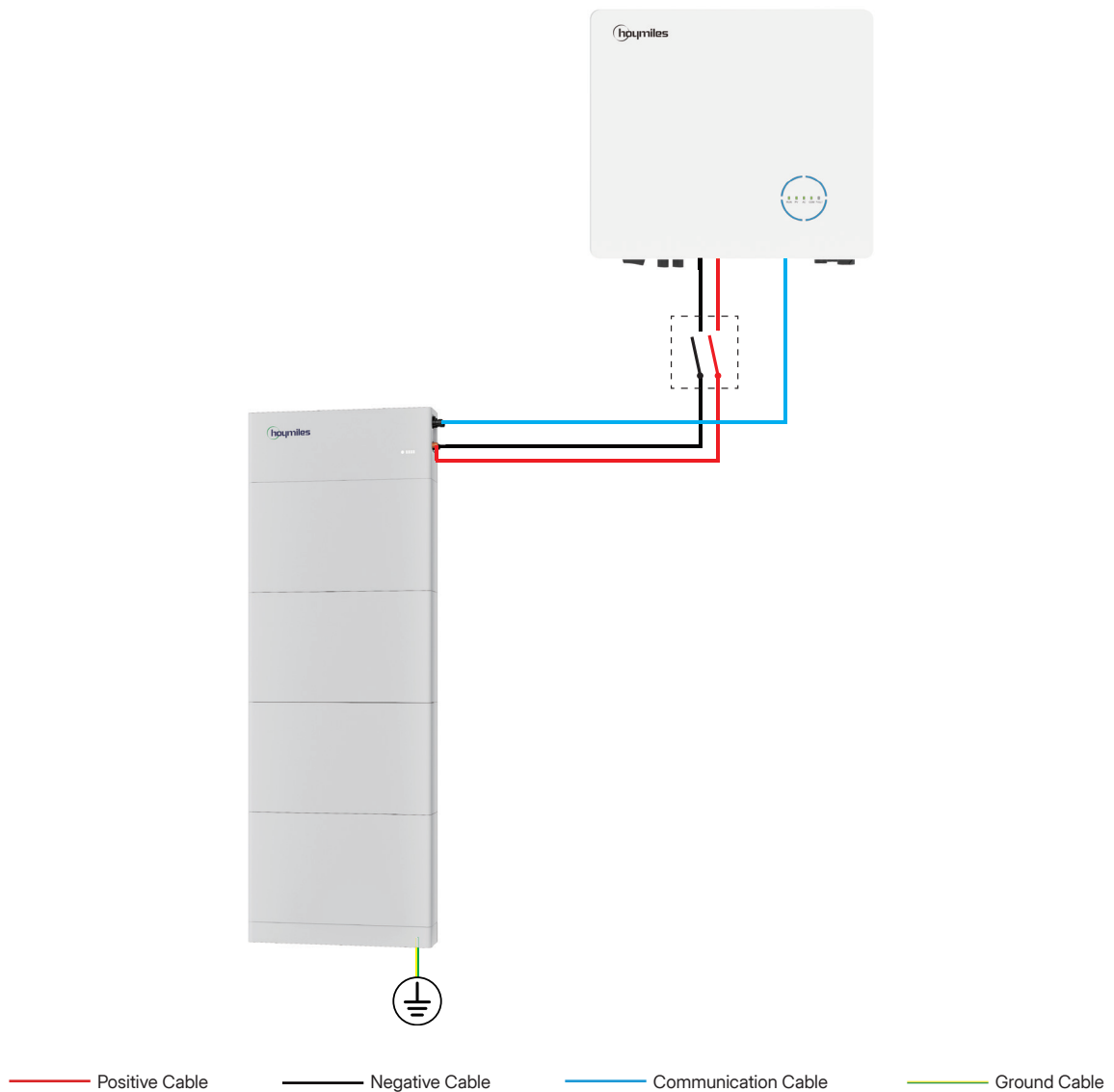

NOTE

- The maximum charging or discharging current of the battery is 200 A. If the current exceeds 200 A, it may cause a risk of fire accident.
- The power of the inverter must not be more than 12 kW.
- If the power of the inverter is less than or equal to 6 kW, use the provided power cables (4 AWG/25 mm²); if the power of the inverter is more than 6 kW, power cables should be purchased separately, and the recommended specification is 2/0 AWG or 70 mm².

4.4.2 Multi-battery System

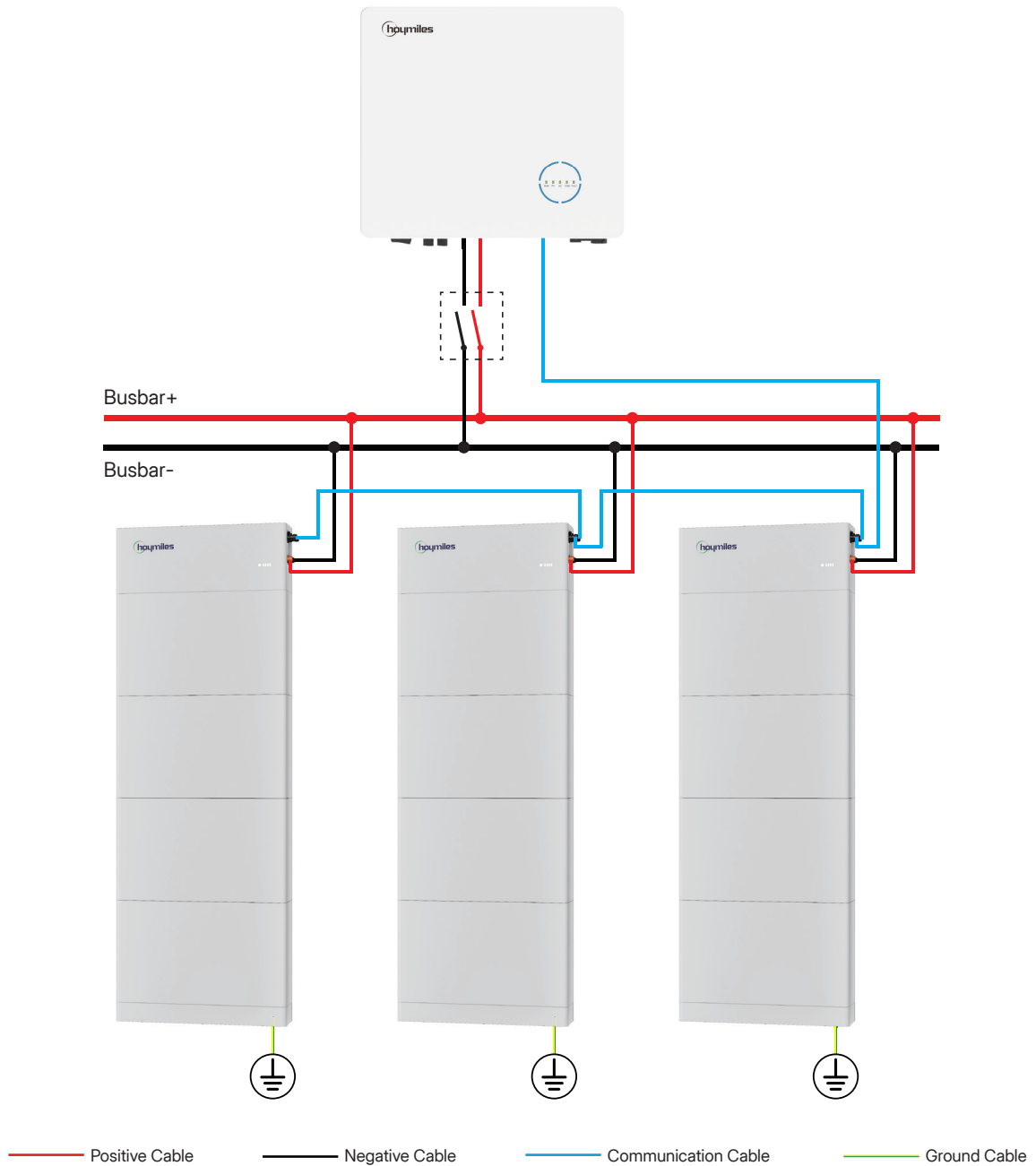

NOTE

- This system supports up to 5 battery towers in parallel.
- The maximum charging or discharging current of the battery is 200 A. If the current exceeds 200 A, it may cause a risk of fire accident.
- Power cables for parallel connection will not be provided by Hoymiles and should be purchased separately. The recommended cable specification is 2/0 AWG or 70 mm².

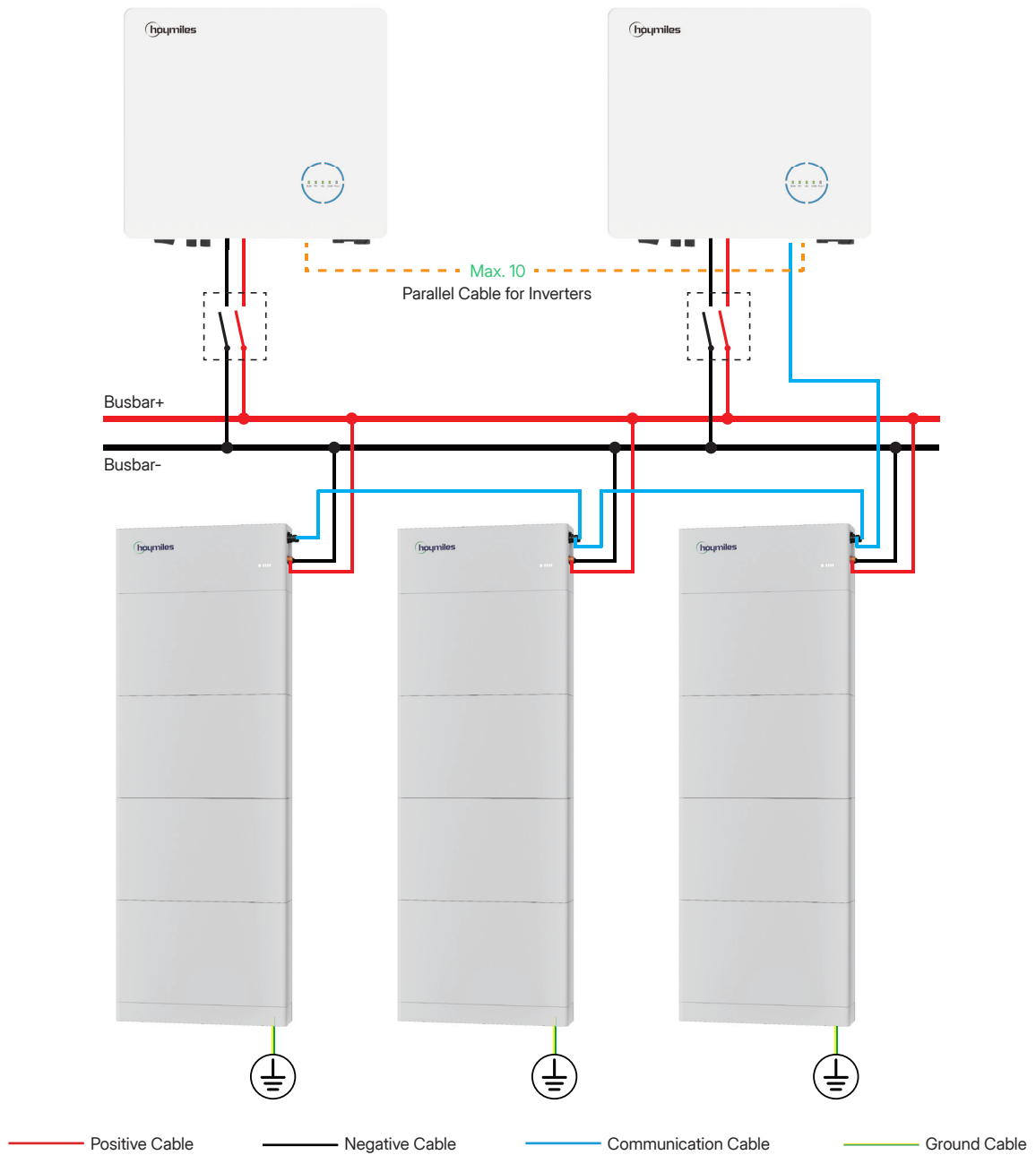

NOTE

- This system supports up to 5 battery towers in parallel.
- The maximum charging or discharging current of the battery is 200 A. If the current exceeds 200 A, it may cause a risk of fire accident.
- Power cables for parallel connection will not be provided by Hoymiles and should be purchased separately. The recommended cable specification is 2/0 AWG or 70 mm².

5 Installation Instruction

⚠ DANGER







Danger to life due to fire or explosion!

- Despite careful construction, electrical devices can cause fires. This can result in death or serious injury.
- Do not mount the product in places containing highly flammable materials or gases.
- Do not mount the product in places where there is a risk of explosion.

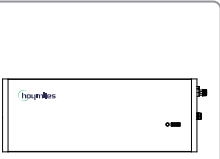
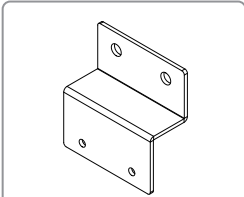



5.1 Unpacking

Unpack the package and carefully take out the product and other accessories. Check that the deliverables are complete and intact after unpacking the battery. Please contact your supplier if the components are missing or damaged upon receipt of the battery.



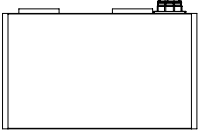



Control Box Packing List

 Control Box*1	 Bracket A*1	 Power Cable*2	 RJ45 Connector*1 Communication Cable*1
 Screw M4*12*2	 Expansion Screw M6*80*2	 Quick Installation Guide*1	 Certificate*1

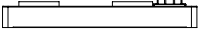
Battery Pack Packing List

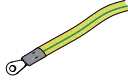
 Battery Pack*1	 Bracket B*1	 Screw M5*10*2	 Certificate*1
---	--	---	--

Base Packing List

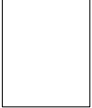
 Base*1	 Bracket B*1	 Ground Cable*1	 Screw M5*10*1
 Screw M5*10*2	 Expansion Screw M6*80*2	 Certificate*1	

5.2 Environmental Requirements

- The installation location must be inaccessible to children.
- The installation location must be suitable for the weight and dimensions of the battery.
- The equipment should be protected from conductive (metal) dust.
- The circuit breaker of the BESS must always be freely accessible.
- The recommended ambient temperature is between 15°C and 35°C.
- The operating temperature should be between -20°C and 50°C.
- The relative humidity should be between 10% and 95%.
- The altitude should be no more than 4000 m.
- The product should be installed in an environment with good ventilation and heat dissipation conditions.
- If the product is installed outdoors, it should meet the following requirements, including but not limited to:
 - a) Avoid direct sunlight.
 - b) Avoid rain, snow, and flood.
 - c) Under the shelter if possible.
- If the product is installed indoors, it should meet the following requirements, including but not limited to:
 - a) Keep distance from doors, windows, or other batteries.
 - b) Keep away from the heating device.
 - c) Keep away from corrosive chemicals.

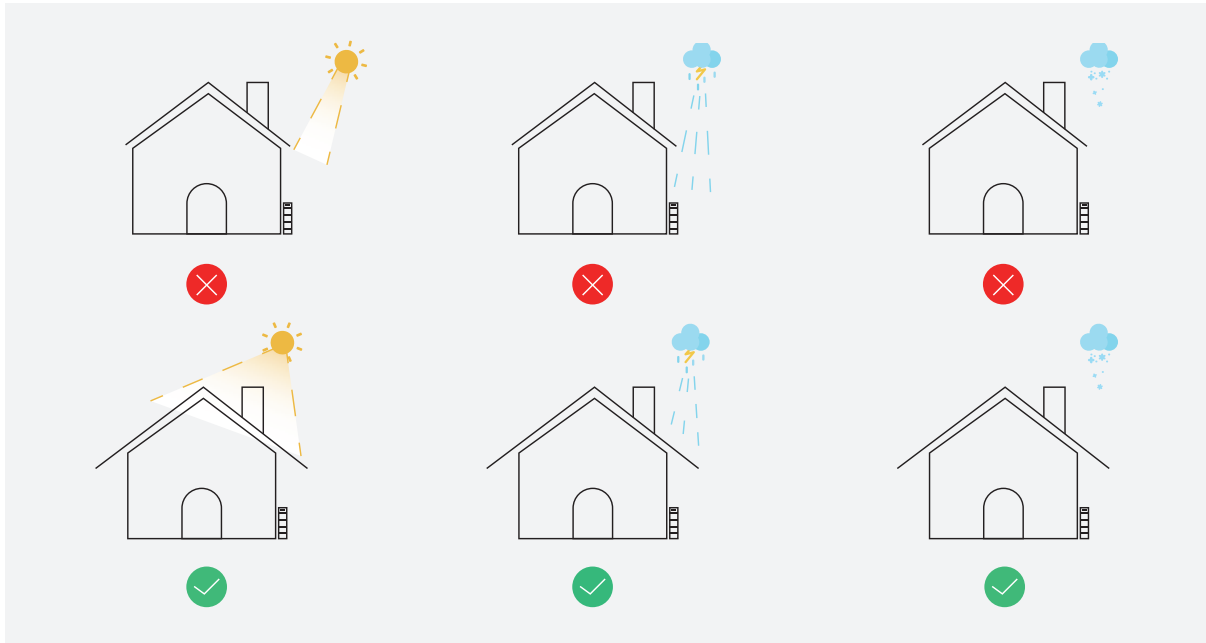

5.3 Space Requirements

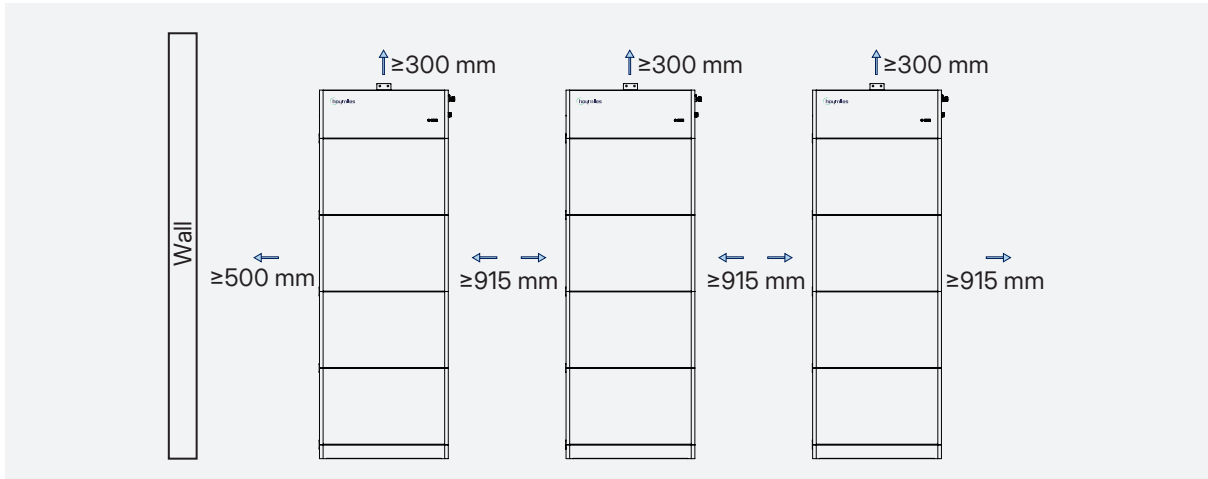

5.4 Stackable Quantity

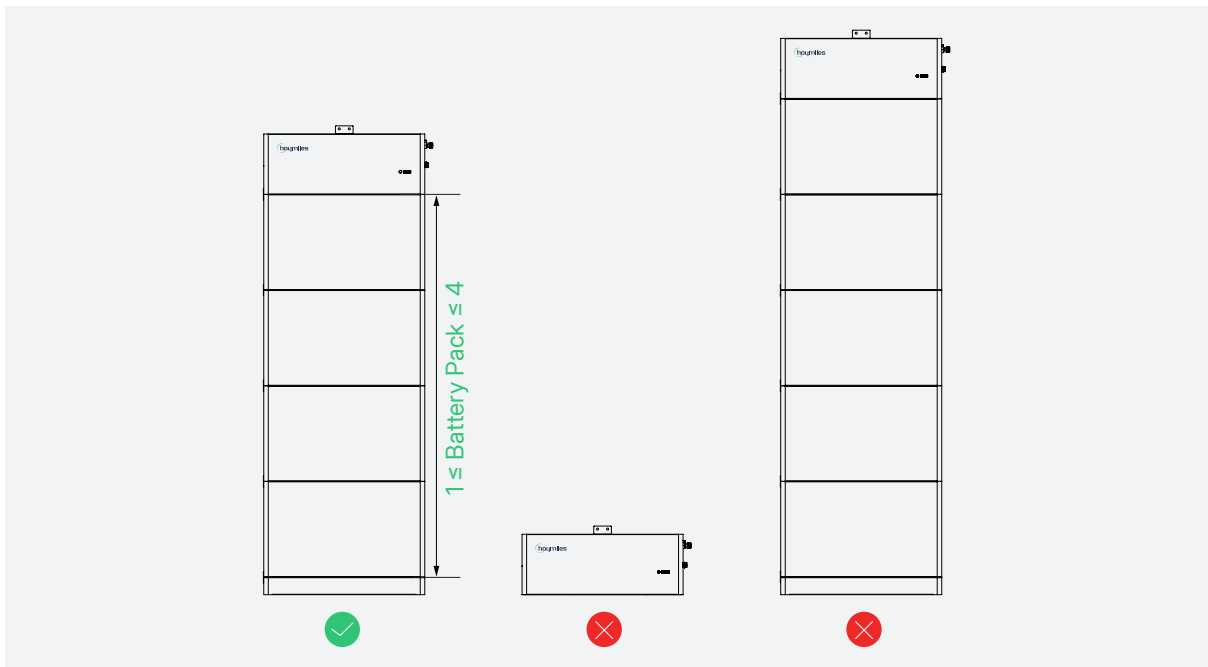

5.5 Installation Tools

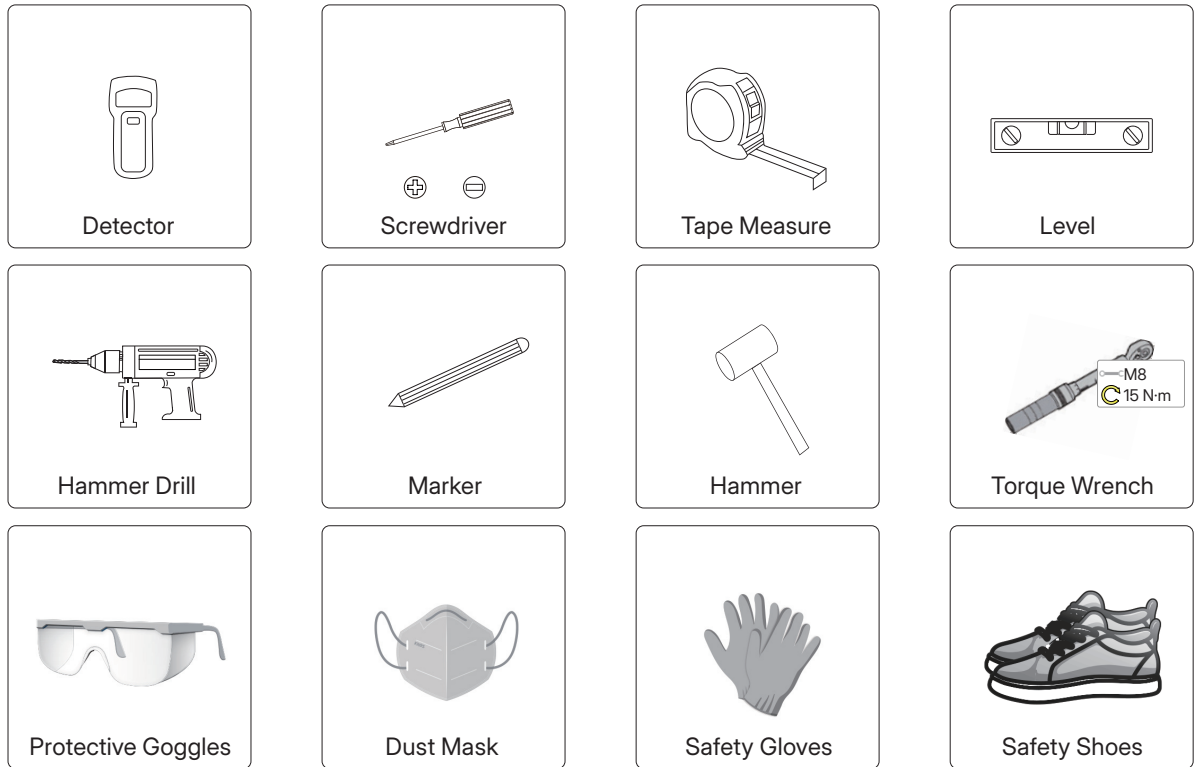

5.6 Installation Steps

Step 1 Installing Bracket A

Fix the bracket A on the top of the control box with a torque of 6 N·m.

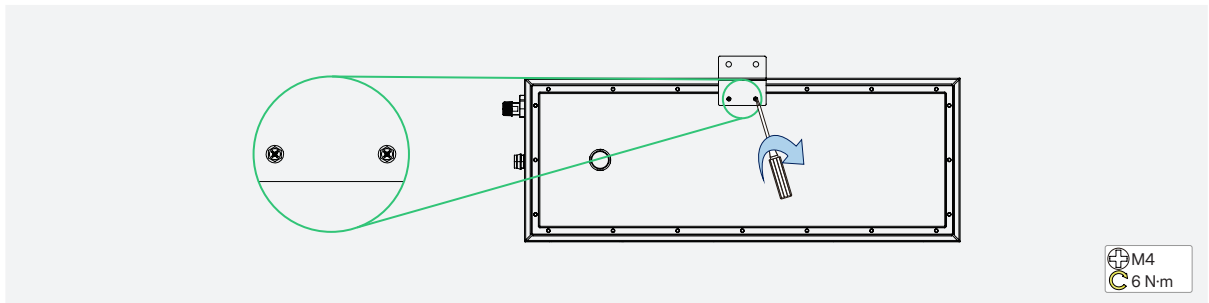

Step 2 Placing Base

- Use a detector to detect whether there are cables or water tubes behind the wall.
- Place the base on a level ground (0° - 3°), parallel to the wall, and keep a distance of at least 30 mm.
- Mark the hole position with a marker, and drill holes with a diameter of 6 mm and a depth of 90 mm.
- Insert the M6*80 expansion screws but do not tighten them.

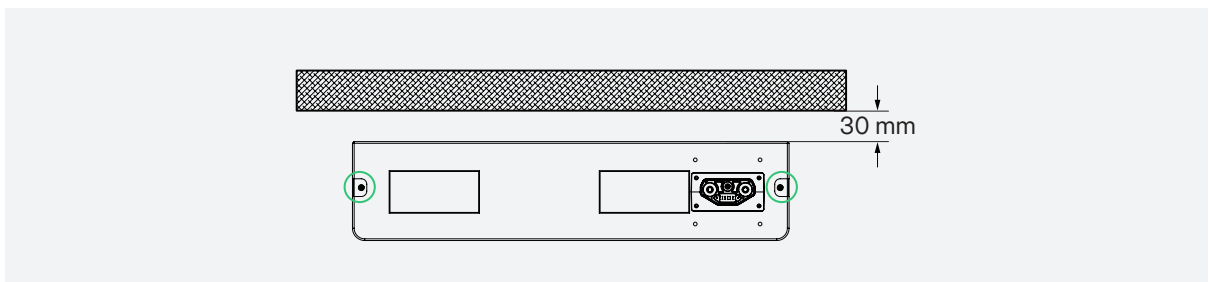

Step 3 Connecting Ground Cable

Because the ground terminal is at the back of the base, you should preinstall the ground cable. Use a M5 screw to secure the connection with a torque of 8 N·m. The specification of ground cable provided by Hoymiles is 6 AWG/16 mm².

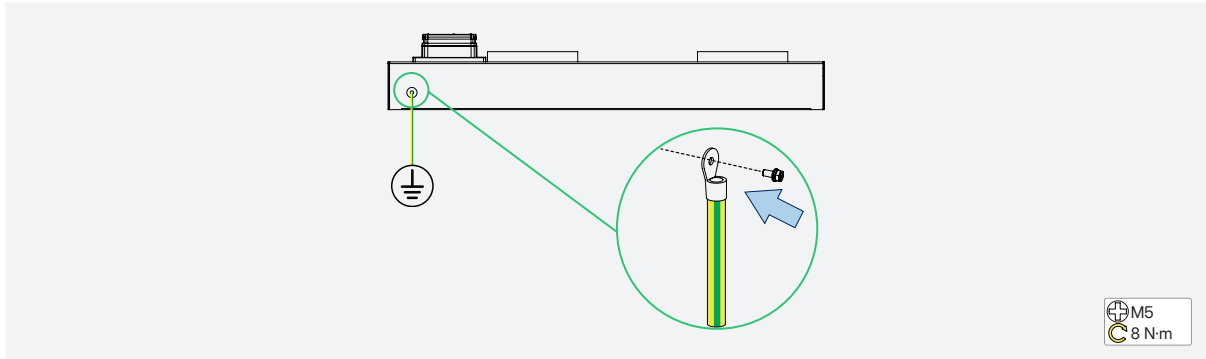

Step 4 Fixing the Base

Tighten the screws to fix the base with a torque of 8 N·m.

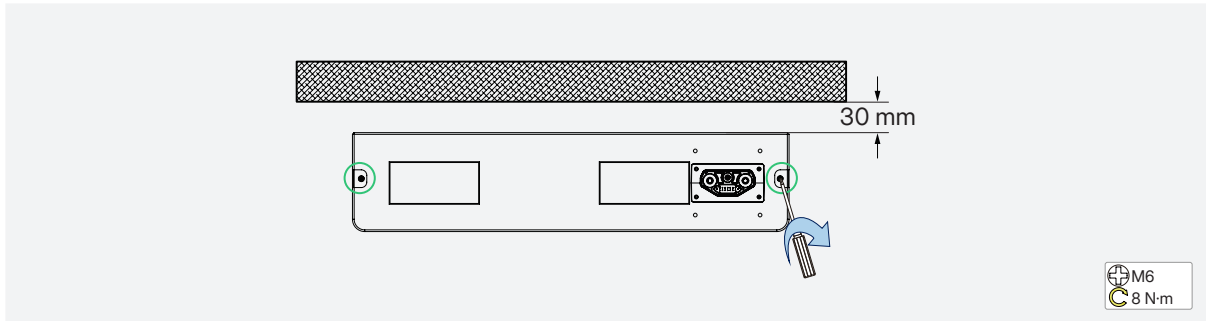

Step 4 Installing Battery Modules

- Hold the handles to lift the upper module and align the connector.
- Slowly put down the connector end of the upper module until the connector ends of the upper module and the base are successfully connected.
- Slowly put down the other end of the upper module.
- Stack other modules layer by layer, and ensure that there is nothing between the wall and the battery.

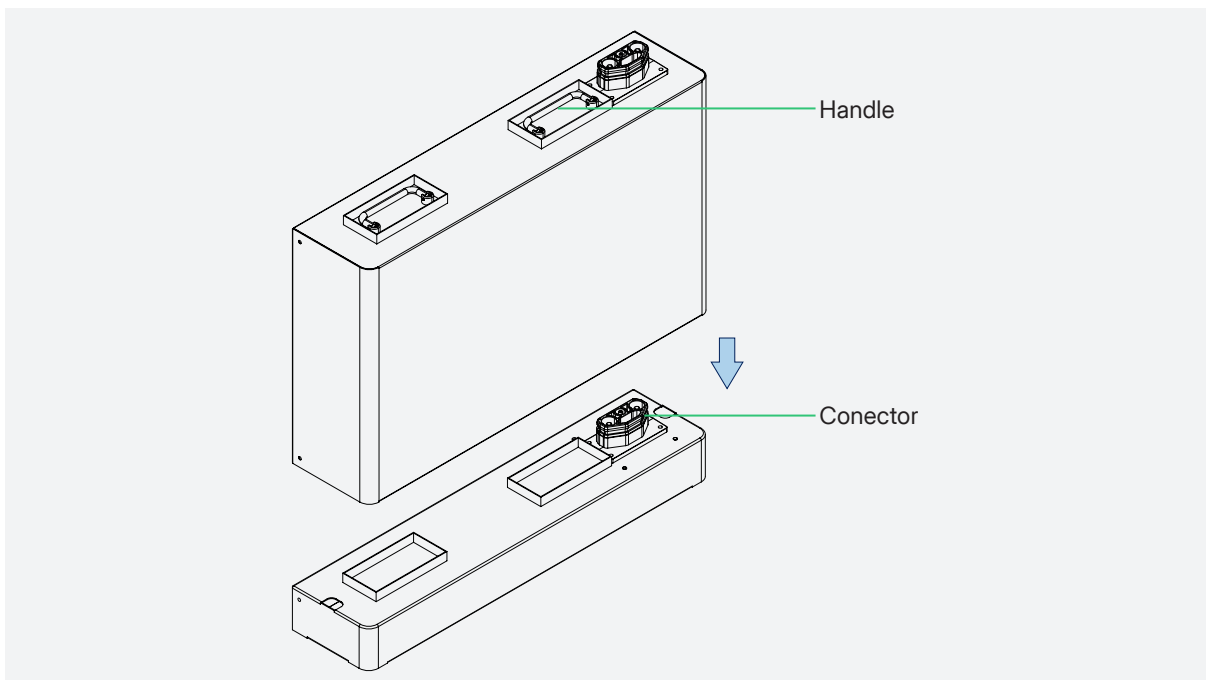

Step 5 Securing the Connection

Use bracket B and M5 screws to secure the connection between battery modules with a torque of 8 N-m.

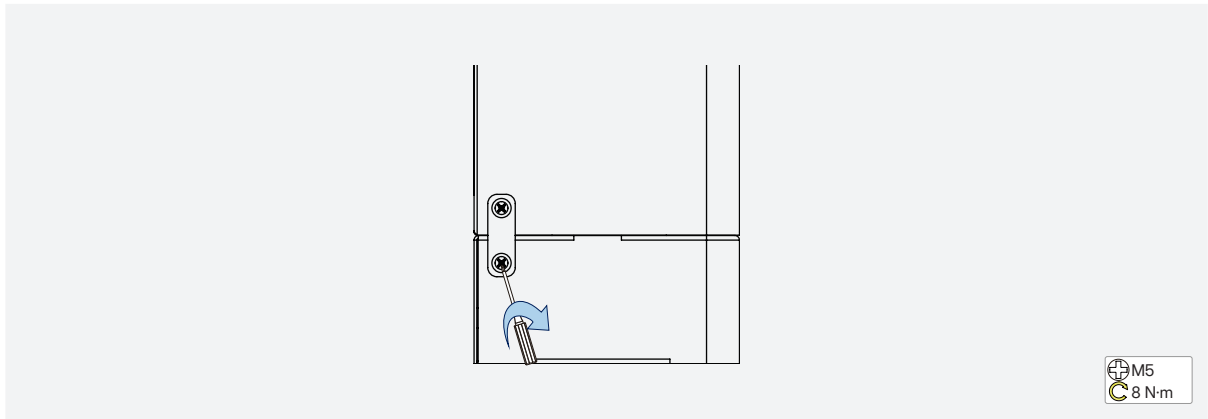

Step 6 Marking the Hole Position

Mark the hole position on the wall with a marker.

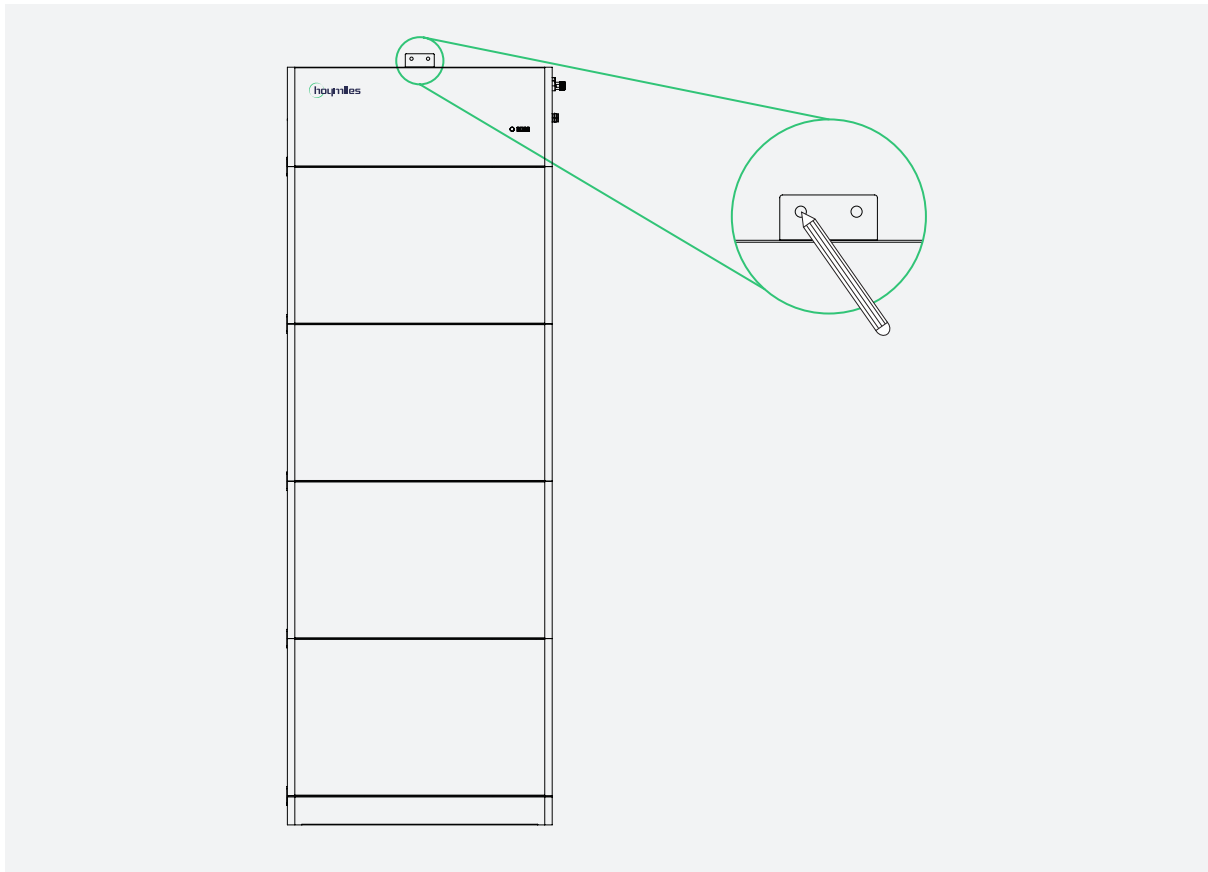

Step 7 Drilling Holes

Drill two holes on the wall with a diameter of 6 mm and a depth of 90 mm using a hammer drill.

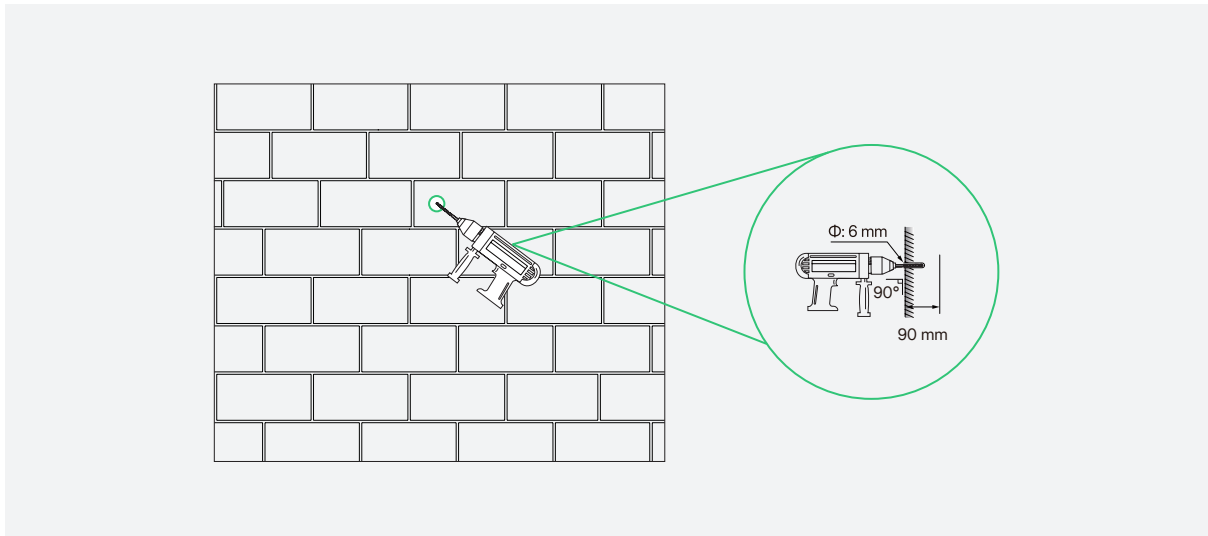

Step 8 Completing the Installation

Place the anchor into the hole, insert the M6 screw into the anchor, and tighten it with a torque of 8 N·m.

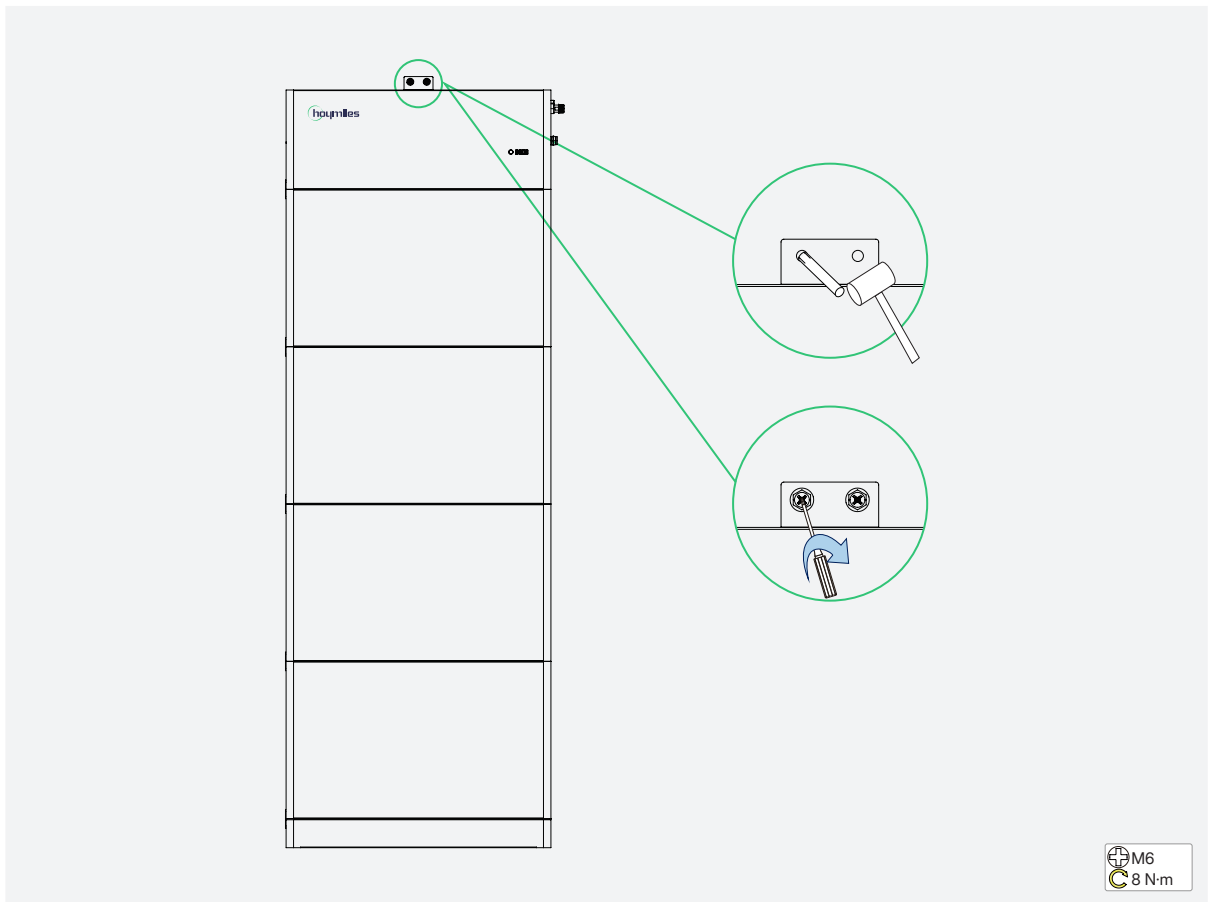

6 Electrical Connection

NOTICE

- Before the electrical connection, disconnect all power suppliers, and ensure that the circuit breaker and all switches connected to the energy storage system are in the OFF state. Otherwise, an electric shock may occur.
- It is recommended that a circuit breaker between the inverter and the battery be installed in accordance with local laws and regulations.

6.1 Single-battery System

Cable	Recommended Specification
Ground Cable	16 mm ² /6 AWG
Positive Cable	25 mm ² /4 AWG
Negative Cable	25 mm ² /4 AWG
Communication Cable	Standard Ethernet Cable

6.1.1 Power Cable Connection

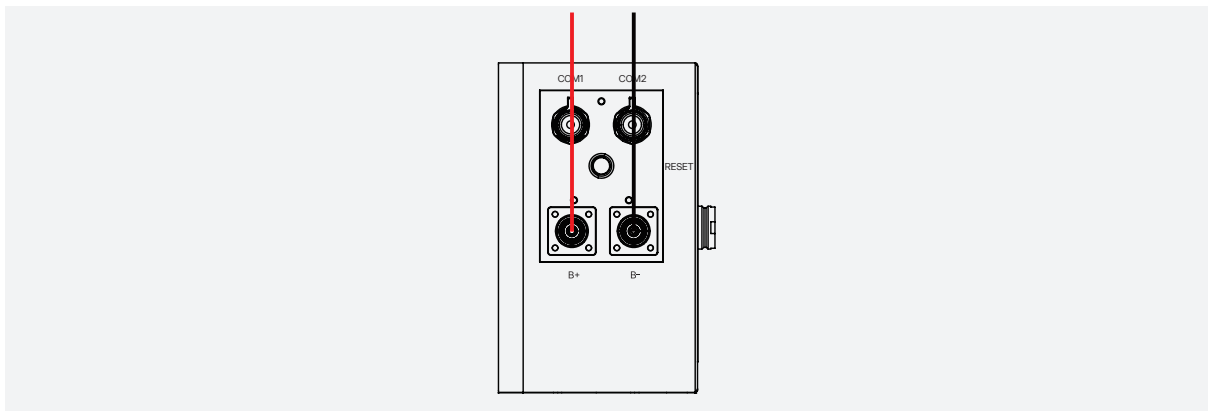

6.1.2 Communication Cable Connection

Step 1 Connect the communication cable.

Step 2 Insert the provided RJ45 connector into the unused communication terminal (COM2).

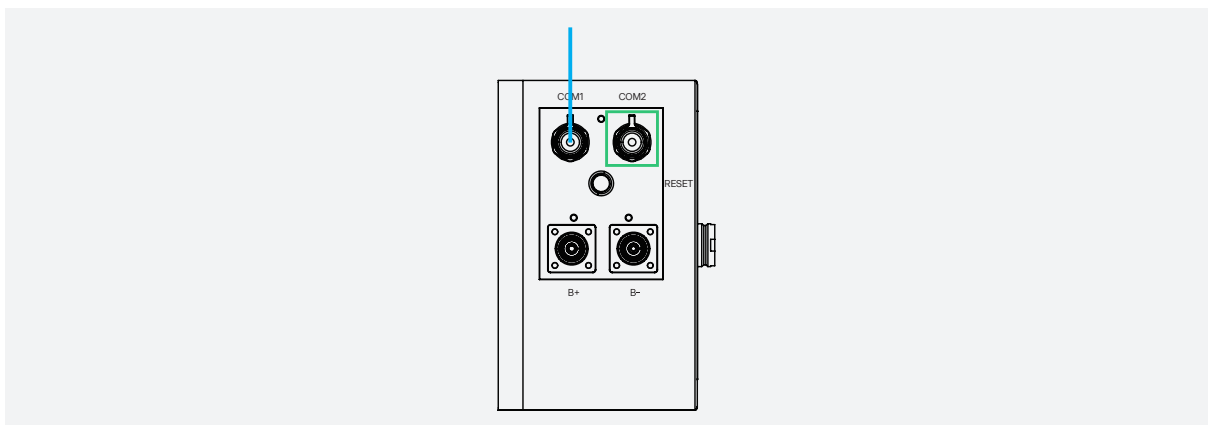

6.2 Multi-battery System

Cable	Recommended Specification
Ground Cable	16 mm ² /6 AWG
Positive Cable	70 mm ² /2/0 AWG
Negative Cable	70 mm ² /2/0 AWG
Communication Cable	Standard Ethernet Cable

6.2.1 Power Cable Connection

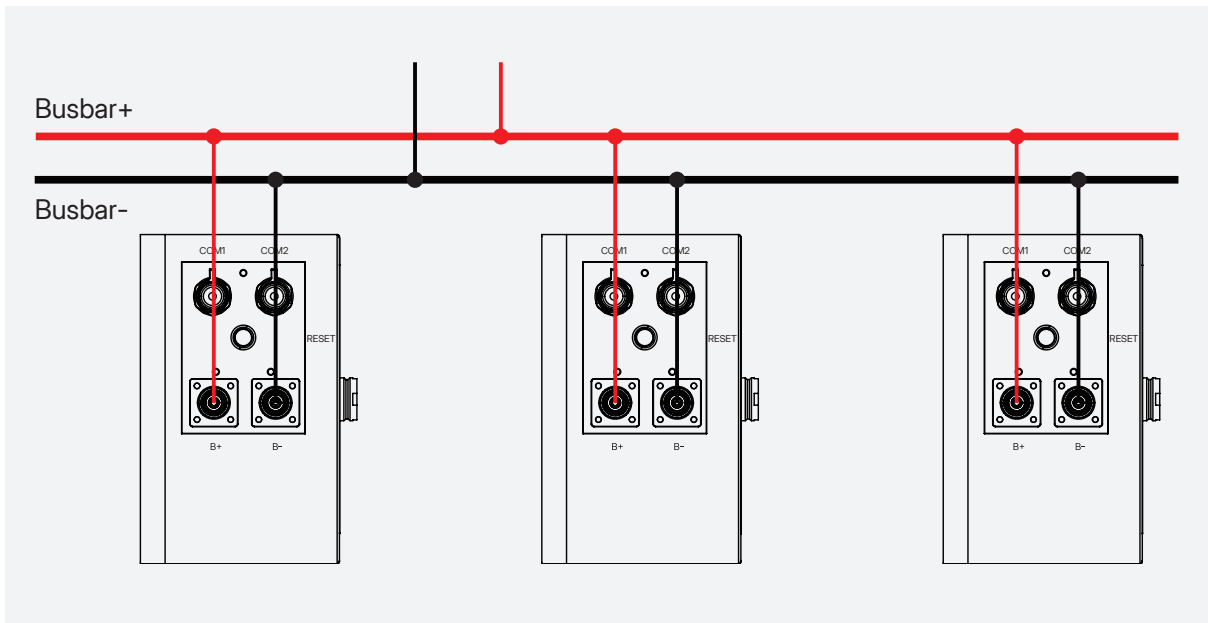

6.2.2 Communication Cable Connection

Step 1 Connect the communication cables.

Step 2 Insert the provided RJ45 connector into the unused communication terminal (COM2).

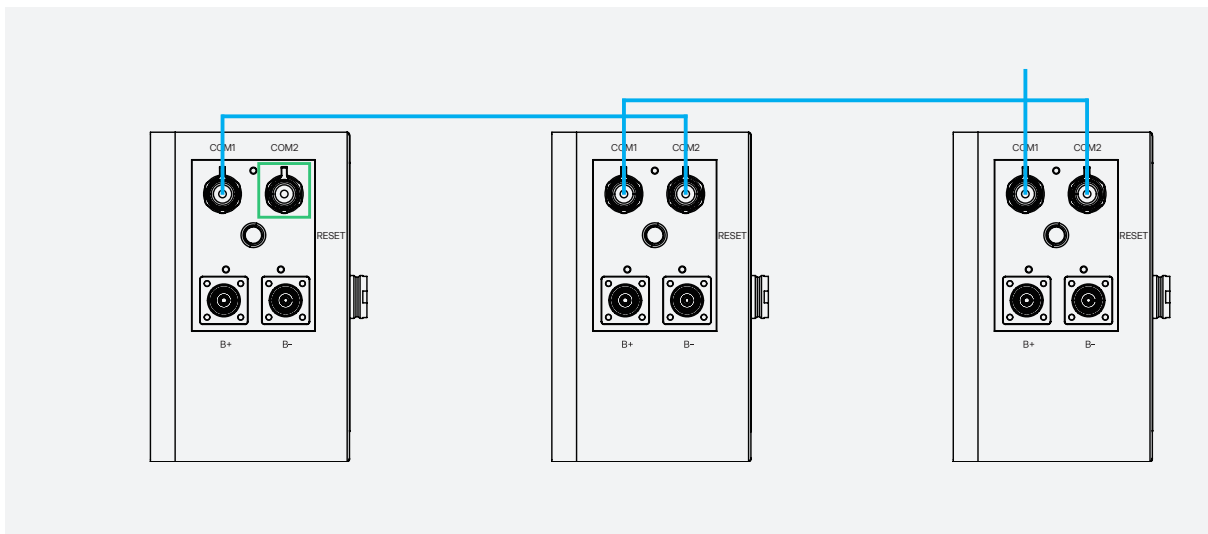

7 System Commissioning

7.1 Preparation

Before the commissioning of the inverter, make sure:

- The power switch and circuit breaker are disconnected.
- Check wiring according to "[6 Electrical Connection](#)".
- Unused terminals must be sealed using corresponding sealing plugs.
- Nothing is left on the top of the inverter and battery.
- Cables are routed in a safe place or protected against mechanical damage.
- Warning signs and labels are intact.

7.2 System Power-on

NOTICE

Ensure that all cables are connected correctly and firmly.

Step 1 Open the cover of the circuit breaker and turn on the circuit breaker.

Step 2 Press the "RESET" button for 3s. The battery will be in self-check state and all indicators will flash blue (0.5s gap).

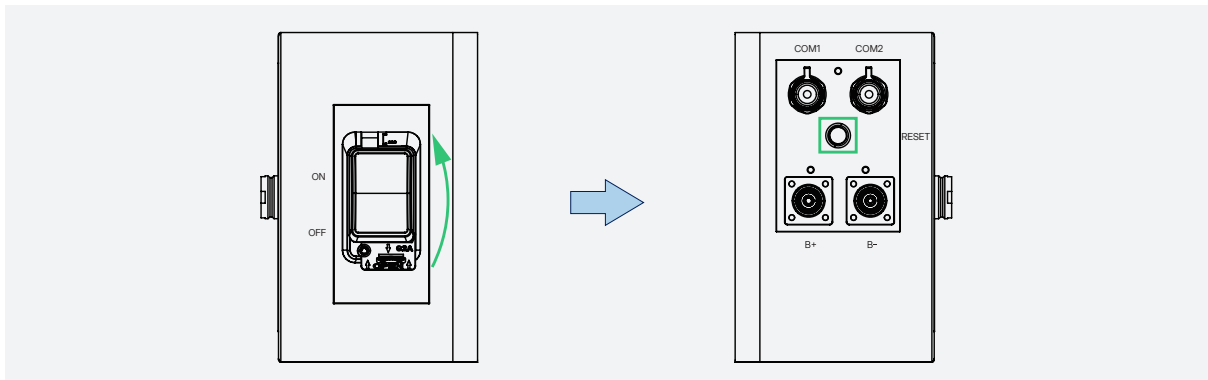

8 System Maintenance

8.1 System Power-off

Step 1 Press the “RESET” button for 3s, the “State” indicator will be solid green, and the “SOC” indicators will be in current status. All indicators will be off after you release the button.

Step 2 Open the cover of the circuit breaker and turn off the circuit breaker.

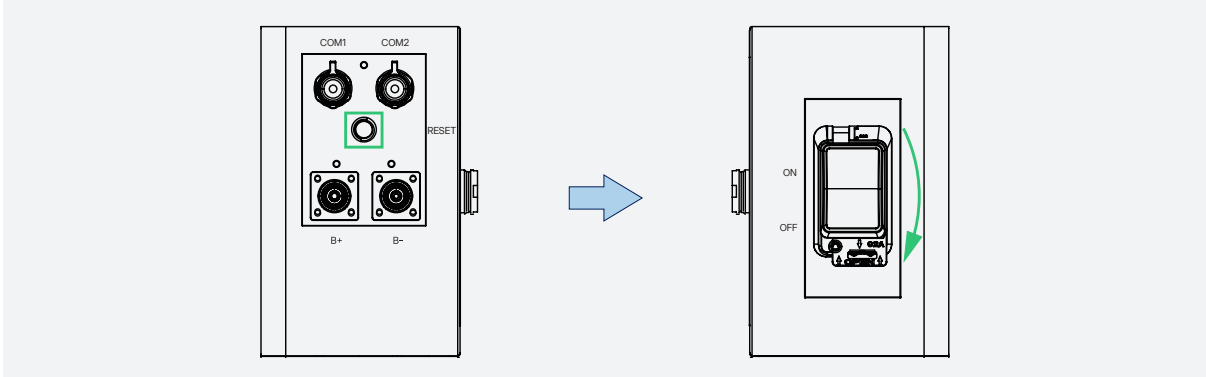

8.2 Routine Maintenance

To ensure that the battery can operate for a long time, it is recommended to perform the following maintenance items. Make sure that all maintenance items are performed after the battery is powered off.

Check Item	Check Method	Maintenance Interval
System Cleanliness	<ul style="list-style-type: none"> Periodically check whether the battery is damaged or deformed. Clean the system. 	Once every 6 to 12 months
System Operation Status	<ul style="list-style-type: none"> Check whether there is abnormal sound during operation; Check whether the indicator works normally. Check whether the system parameters are set correctly. Update the software. 	Once every 6 months
Electrical Connection	<ul style="list-style-type: none"> Check whether the cables are firmly connected and intact; in particular, ensure that the parts being contacted with the metal surface are not scratched; Check whether the cable is discolored. 	The first inspection is 6 months after the initial commissioning, and the subsequent inspections can be carried out once every 6 to 12 months.
Grounding Reliability	<ul style="list-style-type: none"> Check whether the ground cables are firmly connected. 	The first inspection is 6 months after the initial commissioning, and the subsequent inspections can be carried out once every 6 to 12 months.

8.3 Troubleshooting

Fault	Possible Causes	Handling Suggestions
The "RESET" button has no response	The button is broken; The cables are damaged or not properly connected.	Please contact the supplier to repair or replace the battery.
The discharge time decreases abnormally	The battery capacity is insufficient.	Charge the battery until it is fully charged.
	Low ambient temperature.	Ensure that the product works within the recommended temperature range.
	Overload.	Check the load status and remove non-essential loads.
	Battery aging and capacity fading.	Please contact the supplier to replace the battery.
Unable to charge and discharge	The battery is discharged to the protection SOC.	The battery should be charged to a value greater than the discharge protection SOC.
	Overvoltage protection.	Log in to the S-Miles App, view the fault information, and contact the supplier.
	Undervoltage protection.	
	Overtemperature protection.	
	Undertemperature protection.	
	Internal fault.	
After the system is started, the indicator is not on or the indicator is abnormal	The battery SOC is low.	Log in to the S-Miles App to check if the SOC is low, if it is, contact the supplier to forcibly charge the battery.
	The indicator is damaged.	Please contact the supplier to repair or replace the battery.
Battery communication is abnormal	The communication is disconnected.	Check whether the battery packs are installed reliably, and confirm whether the battery is abnormal through the battery indicator status.
The "State" indicator is solid red	Other faults.	Log in to the S-Miles App, view the fault information, and contact the supplier.
The battery doesn't work	The battery voltage is too low, or the battery SOC is lower than the shutdown protection value.	After the inverter is connected to the grid, charge the battery.

9 Decommissioning

9.1 Removing the Product

Step 1 Power off the product as described in "[8.1 System Power-off](#)".

Step 2 Disconnect all cables.

Step 3 If needed, remove the product and the brackets from the wall.

9.2 Packing the Product

If the original package is available, put the product and its accessories into the package and keep it in a dry and proper place.

If the original package is not available, put the product and its accessories into a suitable package. The package should be easy to remove, can bear the weight of the inverter, and can be sealed properly.

9.3 Disposing of the Product

Disposal of the system must comply with applicable local regulations for the disposal of electronic waste and used batteries.

- Do not dispose of the battery system with your household waste.
- Avoid exposing the battery to high temperatures or direct sunlight.
- Avoid exposing batteries to high humidity or corrosive environments.
- For more information, please contact the original manufacturer.

10 Handling Precautions and Guidelines for Product

These Handling Precautions and Guidelines for Rechargeable Battery System ("Handling Precautions and Guidelines") shall only apply to the packs manufactured by Hoymiles. Customers shall strictly follow these Handling Precautions and Guidelines, and shall alert its customers, contract manufacturers, agents, distributors, service providers, and end-users of the risks of the packs. Customers should also ensure that they observe their obligations as specified in the document and the handling precautions and guidelines. Detailed information is available on the printed label of the product, a quick installation guide, a help file, or an official website. The entire chain including customers, distributors, and end-users should be committed to these obligations so that the product can be properly handled, transported, installed, operated, and maintained.

Statement (1):

Customers are requested to contact Hoymiles in advance, if and when customers need other applications or operating conditions other than those described in this document. Additional experimentation may be required to verify performance and safety under such conditions.

Statement (2):

Hoymiles will take no responsibility for any accidents in the event the product is used for applications or under conditions other than those described in this document.

- Use the product under specified charge/discharge conditions.
- Do not immerse the product in water.
- Do not heat the product.
- Do not attempt to crush, drop, or penetrate the product.
- Do not attempt to have any modifications.
- Leave the product in cool places.
- Stop using the product with any color change or mechanical damage detected during assembly, charging, normal operation, and storage.
- In case of leakage or smells, track to the thermal source, remove the thermal source, and clean it with water.
- Do not place or leave the pack and equipment in the reach of the children.
- Keep leaked electrolytes away from the eyes or skin. In case of leakage contact with eyes or skin, immediately clean with water and seek help from a doctor. Serious damages can be caused due to delayed treatment.
- Do not put the pack into a fire. Do not use it or leave it in a place near fire, heaters, or high-temperature sources. The heat can melt the pack insulator and damage the safety vent, resulting in overheating, explosion, or fire of the pack.
- Do not submerge the product in water or wet the product. If the protective devices are damaged, abnormal charging current and voltage may cause a chemical reaction within the product, which may result in overheating, explosion, or fire of the pack.
- Do not reversely connect the positive (+) and negative (-) terminals of the product.
- Do not contact the product terminals (+ and -) directly with a wire or any metal (like a metal necklace or a hairpin). Otherwise, the product will be short-circuited and generate excessive current, which may result in the overheating, explosion, or fire of the pack.
- Do not throw or drop the pack. Strong impact may damage the protective devices, and an abnormal chemical reaction might occur during charge, resulting in overheating, explosion, or fire of the pack.
- Do not drive a nail in, hit with a hammer, or stamp on the pack. Otherwise, the pack may be deformed and short-circuited, resulting in overheating, explosion, or fire of the pack.
- Do not solder the pack directly. Heat applied during soldering may damage the insulator of the safety vent and mechanism, resulting in overheating, explosion, or fire of the pack.
- Do not disassemble or alter the pack. The pack employs a safety mechanism and a protection device to avoid any danger. If they are damaged, the pack might overheat, explode, or catch fire.
- Do not put the pack in a microwave oven or a pressure cooker. Sudden heat may damage the sealing of the pack and may cause overheating, explosion, or fire of the pack.
- Do not leave the pack in a charger or equipment if it generates an odour and/or heat, changes color and/or

shape, leaks electrolytes, or encounters any other abnormality. In such a case, immediately take the pack out of the charger or equipment and keep it away from fire. Otherwise, the pack might overheat, explode, or catch fire.

- Stop charging or using the battery after the battery reaches its lifetime; otherwise, the battery might cause overheating, explosion, or fire.
- Do not use the pack beyond specified conditions. Otherwise, the pack might encounter overheating, damage, or performance deterioration.
- Read the instructions regarding the installation and operation to avoid damages due to incorrect operations.
- The battery may have insufficient power capacity after long storage.
- Knockoff or counterfeit battery.
- Any inconsistency among serial number, model number, and product code.

11 Technical Datasheet

Model	LB-5S-G2	LB-10S-G2	LB-15S-G2	LB-20S-G2
System Data				
Battery type	LiFePO ₄			
Rated capacity (Ah)	100	200	300	400
Number of modules	1	2	3	4
Total energy (kWh)	5.12	10.24	15.36	20.48
Rated voltage (V)	51.2			
Voltage range (V)	44.8-58.4			
Rated charging/discharging current	0.5C			
Max. continuous charging/discharging current (A)	50	100	150	200
Max. charge/discharge power (kW)	2.56	5.12	7.68	10.24
Peak charge/discharge power (kW)	3.84 (10s)	7.68 (10s)	11.52 (10s)	15.36 (10s)
Communication	CAN, RS485			
Recommended depth of discharge (DOD)	90%			
Max. scalability	5			
Protection				
Overvoltage and undervoltage protection	Integrated			
Overcurrent protection	Integrated			
Overtemperature and undertemperature protection	Integrated			
DC breaker	Integrated			
General				
System dimensions (including base) (W × H × D [mm]) ⁽¹⁾	640 × 690 × 145	640 × 1070 × 145	640 × 1450 × 145	640 × 1830 × 145
System weight (including base) (kg) ⁽¹⁾	60.5	107	153.5	200
Control box dimensions (W × H × D [mm])	640 × 240 × 145			
Control box weight (kg)	11			
Single PACK dimensions (W × H × D [mm])	640 × 380 × 145			
Single PACK weight (kg)	46.5			
Installation environment	Indoor/Outdoor			
Charging temperature (°C)	0 to +50			
Discharging temperature (°C)	-20 to +50			
Protection degree	IP66			
Cooling	Natural convection			
Altitude (m)	≤4000			
Cycle life (25°C, 0.5C)	6000 Cycles, @90% DOD, 70% EOL			
Certification	IEC 62619, UN 38.3, CE-EMC			
Warranty ⁽²⁾	5-10 Years			

(1) The actual dimensions and weight may differ. For details, please contact Hoymiles sales.

(2) Please refer to Hoymiles Warranty Terms & Conditions for more details.



Floor 6-10, Building 5, 99 Housheng Road, Gongshu District,
Hangzhou 310015
P. R. China
+86 571 2805 6101

General inquiry: info@hoymiles.com
Technical support: service@hoymiles.com

Visit <https://www.hoymiles.com/> for more information.